



## Applications

- Photovoltaic Testing
- Material Characterization and Degradation Testing
- Photochemistry
- Accelerated Age Testing

## Features

- Industry Leading Efficiency
- Class AAA
- Turn-key Operation
- Suitable for larger target areas
- Electronic shutter control
- Includes AM1.5G Filter
- Vertical with option for horizontal operation

# UHE Solar Simulators

## NS and NL-Series



# UHE Solar Simulator Series

## OVERVIEW

The UHE-NS and UHE-NL solar simulator series are class AAA and have turn key operation system. Due to their very high efficiency these can be used for larger target areas and larger distances.

The UHE-NS/NL family of solar simulators are feature rich, convenient integrated systems suitable for a variety of research and testing requiring a stable and reliable uniform light source. UHE-NL series solar simulators can produce 1 Sun or more solar irradiance at a variety of solar spectral classifications (with an appropriate AM filter).

All of the electronics are contained inside the UHE-NL system to reduce clutter. With the UHE-NL all of the simulator functions can be controlled from a single touch screen interface or from the provided Sciencetech Power Control software.

### Specifications

Model	UHE-NS-75	UHE-NS-100	UHE-NS-125	UHE-NL-150	UHE-NL-200	UHE-NL-250	UHE-NL-300
SKU Number	166-9026	166-9026	166-9032	166-9028	166-9029	166-9030	166-9031
Solar Simulator Type	Steady-State						
Test Plane Area. 1 Sun. AM1.5G (mm)	75x75	100x100	125x125	150x150	200x200	250x250	300x300
Test Plane Area. 1 Sun. AM0 (mm)	50x50	70x70	80x80	100x100	140x140	175x175	200x200
Solar Simulator Classification	AAA	AAA	AAA	AAA	AAA	AAA	AAA
Spectral Range (nm)	300-1800						
Spectral Match Classification	Class A. All intervals (0.75 < RSM* > 1.25). Different Spectral filters available.						
Spatial non-uniformity of Irradiance Classification	< 2% A	< 2% A	< 2% A	< 2% A	< 2% A	< 2% A	< 3% A
Temporal Instability of Irradiance Classification	A (<1% over 1 second)			A (<1% over 10 seconds)			
	A (<2% over 10 seconds)			A (<2% over 20 minutes)			
Collimation Half angle (degrees)	<8	<8	<8	<8	<9	<9	<10
Working Distance (mm)	225	225	300	500	575	650	650
Lamp Type	Xenon Short Arc						
Lamp Wattage (watts)   Model	300, (XE300)	300, (XE300)	550 (XE550)	500, (XE500)	1000, (XE1000)	1600, (XE1600)	1600, (XE1600)
Irradiance Control	0.8 - 1 sun						
Control Unit	Integrated Touchscreen Control Unit						
Dimensions (L×W×H) (mm)	431×308×1461 (V) / 1461× 308×431x (H)			970×437×1917 (V) / 1917×437×437 (H)			
Weight (kg)	80			95			
Power Supply Model	Integrated						
Power Requirements	100-120V, 50-60Hz 4A or 200-240V, 50-60Hz 2A		100-120V, 50-60Hz 10A or 200-240V, 50-60Hz 5A		220-240V/ 50Hz, 10A		

- Typical values are listed. Values for each shipped unit may vary from the specifications.
- Irradiance control can be performed using control unit. Typically values above 1 sun can be reached.

# UHE Solar Simulator Series

## CONFIGURATION

Both series are designed for either downward facing or horizontal beam operation. In downward facing beam orientation both the UHE-NS and UHE-NL produces uniform light slightly above standard desk height. This configuration allows for operation of the simulator from either a standing or seated position.

- Large testing area and working distances can be achieved for easy integration.
- Numerous sample area accessories, instrument configuration options and accessories are available.
- See the configuration options at the end of this brochure for more information and dimensions.

## Quality Control procedures for Solar Simulator Classifications

UHE-NS/NL simulators are aligned and tested in our calibration laboratory. Strict quality control procedures are enforced to ensure simulators meet the required specifications. Uniformity, Spectral Match, Temporal Instability and irradiance level are measured for each simulator. Our simulators are designed to meet the following standards\*:

- ASTM E 927
- IEC 60904-9
- JIS C 8912

Testing is performed to meet ASTM E927-19. All Following testing results are for an example UHE and individual reports will vary.

### Class A Spatial Non-uniformity Performance

Uniformity is defined as :

$$\text{Uniformity (\%)} = (\text{Max Irradiance} - \text{Min Irradiance}) / (\text{Max Irradiance} + \text{Min irradiance}) \times 100\%$$

In accordance with ASTM E927-19 measured with 64 points in 8 x 8 grid at an intensity of 1 sun.

	Value	Units
<b>Number of Measurement Points:</b>	64	-
<b>Measurement Point Area:</b>	1.56	cm <sup>2</sup>
<b>Maximum Irradiance:</b>	1.0191	Suns
<b>Minimum Irradiance:</b>	0.9826	Suns
<b>Sample Standard Deviation of Spatial Non-Uniformity:</b>	0.008	Suns
<b>Spatial Non-Uniformity of Irradiance:</b>	1.8	%
<b>Classification:</b>	A	-

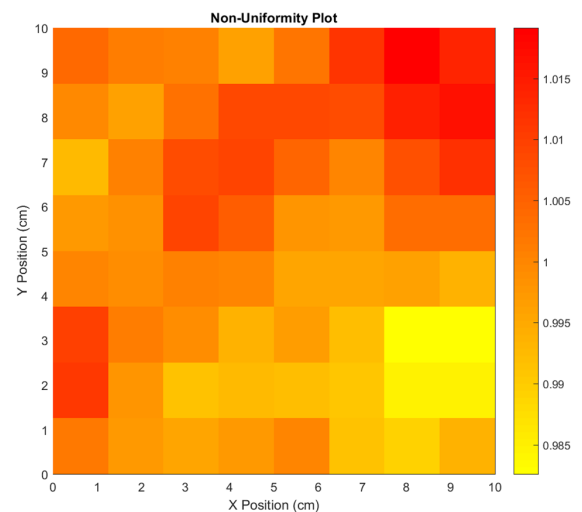

# UHE Solar Simulator Series

## CONFIGURATION

### Class A Spectral Irradiance Match Performance

The system includes an AM 1.5G filter and the Spectral Match Measurement was performed with a stepping-monochromator and silicon photodiode detector using modulated light and sensitive lock-in amplifier in accordance to standards.

Class A spectral match is defined by ASTM G173 as matching the integrated irradiance percentage values to within  $\pm 25\%$  of the total irradiance for each spectral band. Sciencetech provides a much better spectral match than  $\pm 25\%$  and therefore classifies as Class A spectral match.

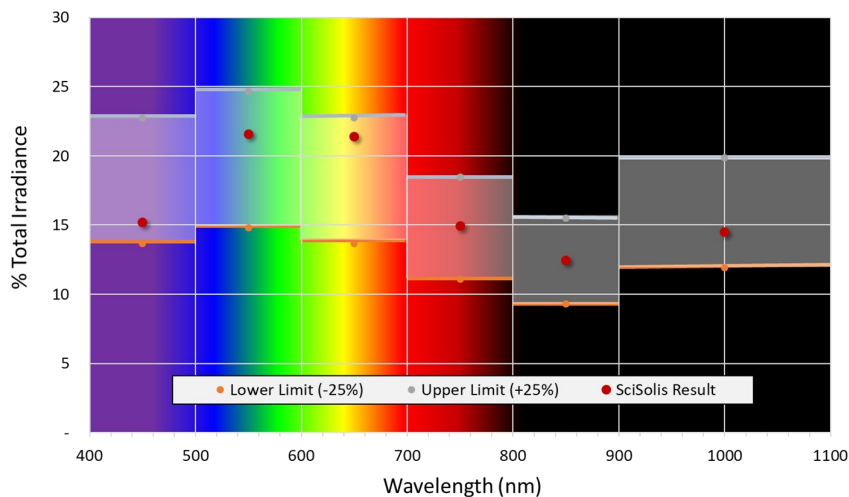
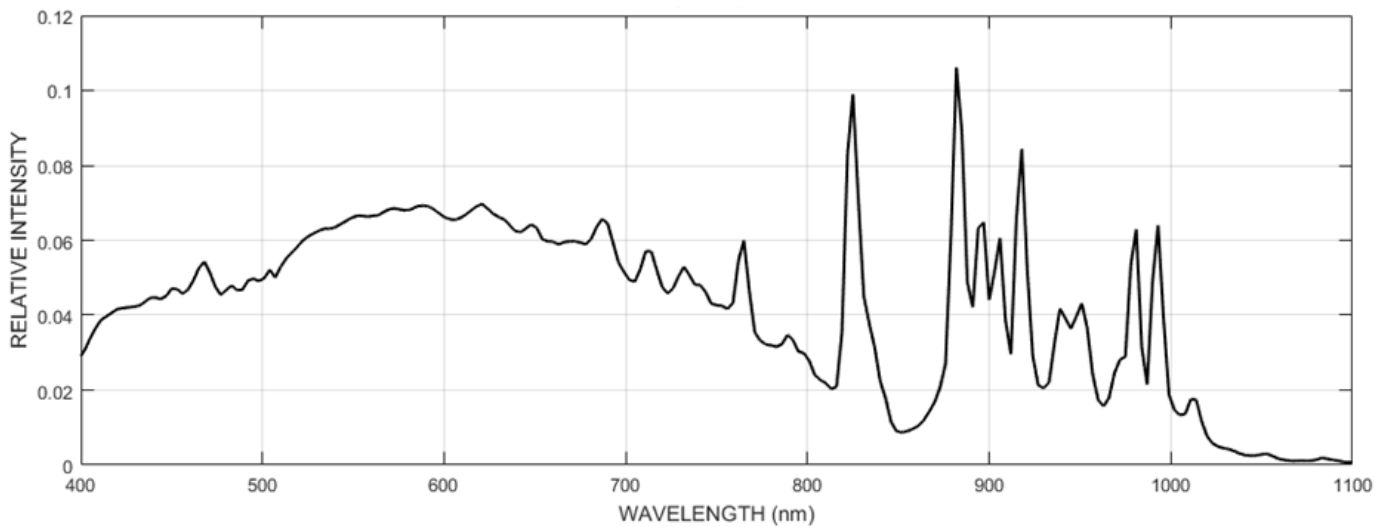

400-500 nm	=	15.1774%	,	Class A
500-600 nm	=	21.5593%	,	Class A
600-700 nm	=	21.3764%	,	Class A
700-800 nm	=	14.9445%	,	Class A
800-900 nm	=	12.4609%	,	Class A
900-1100 nm	=	14.4815%	,	Class A

# UHE Solar Simulator Series

## CONFIGURATION

### Class A Temporal instability of Irradiance

Temporal Instability is defined as:

$$\text{Temporal Instability (\%)} = (\text{Max irradiance} - \text{Min irradiance}) / (\text{Max irradiance} + \text{Min Irradiance}) \times 100\%$$

Temporal Instability is measured by taking 20 samples per second for 10 seconds.

Temporal instability of irradiance was measured in accordance to standards at an intensity of 1 sun illumination on target. Validation performed measuring the short-circuit current of a silicon cell.

	Value	Units
<b>Time Between Data Points:</b>	0.253	seconds
<b>Number of Power Line Cycles (NPLC):</b>	1	-
<b>Total Measurement Points:</b>	20	-
<b>Maximum Irradiance:</b>	1.004	Suns
<b>Minimum Irradiance:</b>	0.9947	Suns
<b>Temporal Instability of Irradiance:</b>	0.46	%

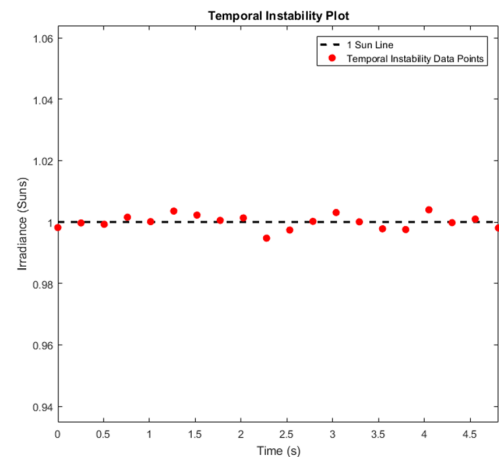

### Filters

Sciencetech's UHE-NS/NL series solar simulators include a two-position filter holder. An add-on upgrade is available to increase the available filter positions to four.

The most popular options are AM filters; however, a range of other filter options are available.

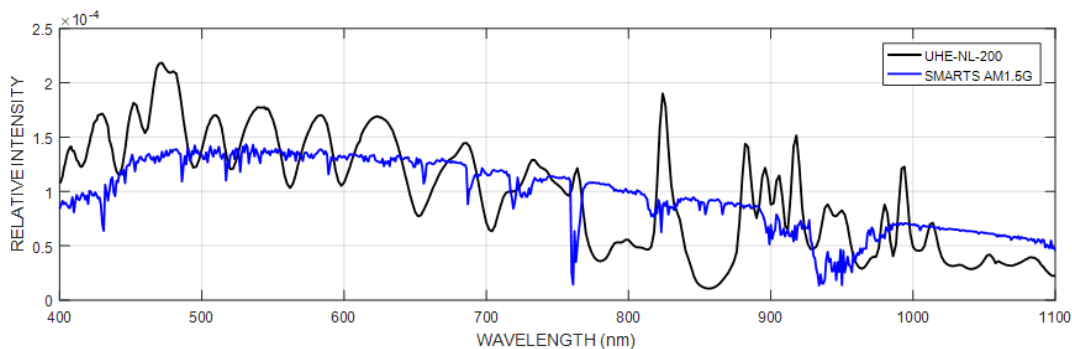

UHE-NL with AM1.5G-FT-3 filter installed providing class A spectral match to the AM1.5G spectrum

# UHE Solar Simulator Series CONTROL UNIT & SOFTWARE

Sciencetech's UHE-NS and UHE-NL solar simulators are controlled from a single touch screen interface control unit. Standard features of the control unit are:

- Touchscreen interface
- Shutter and exposure control (200ms closing/opening time)
- Lamp starts and timer log
- Forced air cooling safety interlock
- RS232 communication
- Power Control software with graphical user interface included,
- Single power line connection for lamp power, cooling, and communication



LAMP ON	LAMP OFF	<input checked="" type="radio"/>	T	21	87.0
				FANS On	88.0
	0.0	<input checked="" type="radio"/>	V	FANS Off	SET
	0.0	<input type="radio"/>	I	FANS OFF	
	0.00			LOG	SHUTTER

## Electronic Shutter Control

This shutter can be used with any high powered light source and can effectively block a 4" diameter beam.

This device is computer controlled through Sciencetech's line of Touch Screen power supplies



CLOSE		OPEN/CLOSE TIME		EX-POSE
		2	2	
SHUTTER				LOOP
STOP LAMP		0	0	
		MAIN	RUNTIME	HELP

## Software Included

UHE systems come with SciLampPower Control.

Additional Software Packages are available for purchase to integrate the UHE into a custom solution.

SciAX - provides ActiveX control modules with HTA examples (LabView example files available with additional purchase)

SciencetechCOM - provides C++ and Python libraries and example files.

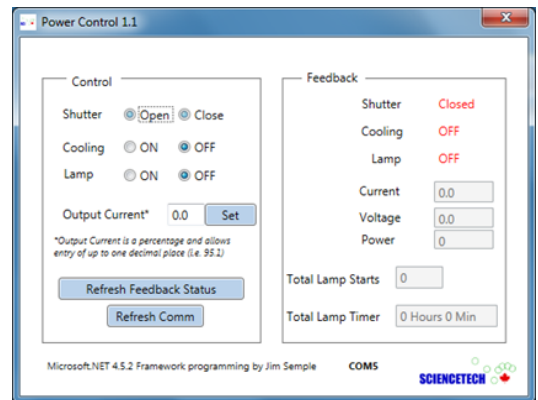
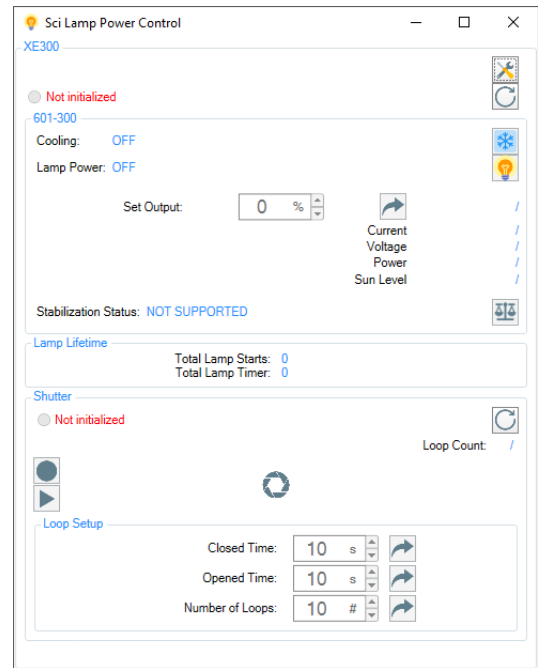

# UHE Solar Simulator Series

## ACCESSORIES



### FILTERS

---

AM1.5G Standard range (Include with all models). Additional option provides AM1.5D, AM1.5G, and AM0 spectral match, and standard range



### IV Measurement System

---

20W IV Tester for Continuous Solar Simulators (current range = 1 A, voltage range =

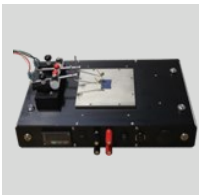

### Cell Chucks

---

3.5" x 3.5" Solar Cell Chuck, TE Cooled, Computer controllable, Vacuum Ready.



### Solar Cell Chuck

---

3.5" x 3.5" Solar Cell Chuck, Liquid Cooled, Rear Contact.

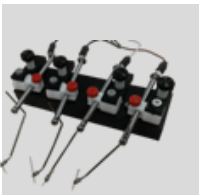

### Probe Station

---

Probe Station, 4 Probes, Tungsten Needle-tip Kelvin Probes

# UHE Solar Simulator Series

## CONFIGURATION OPTIONS

The UHE-NS/NL Simulators can be configured at the time of order. Various options have been designed to cover most requirements. Sciencetech prides itself on providing custom solutions. Please contact a Sciencetech sales engineer and let us know how we can help you!

Code	Part #	Description
-HB	N/A	Horizontal Beam Option (Please specify at time of order)
0	166-8016	Automated Beam Attenuation from 0-100% in 10% Steps
FS-02-N	115-9027	Optical Feedback for Long Term Stability
UHE-DARK	116-8017	Light Tight Sample Area
ADJ-STAGE	166-8018	Manual Adjustable Stage, 250mm travel

Sciencetech offers a wide range of target plane accessories including fully featured cell chucks and IV testing software.

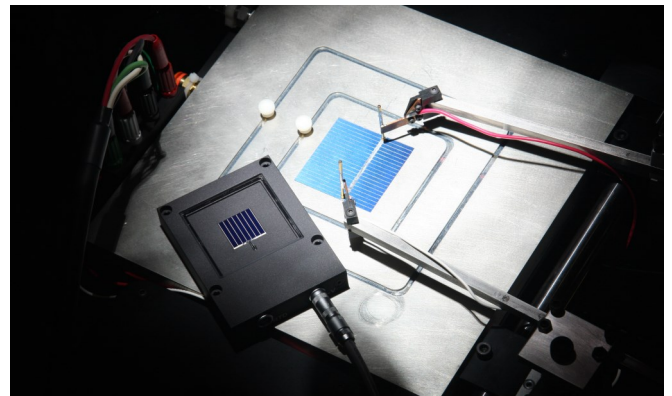

Compatible cell chucks for each solar simulator model:

✓ = Ideal , × = not compatible, U = chuck undersized, compatible

Cell Chuck Family	UHE-NS-75	UHE-NS-100	UHE-NS-125	UHE-NL-150	UHE-NL-200	UHE-NL-250	UHE-NL-300
SCI-SCC3 (75x75mm)	✓	U	U	U	U	U	U
SCI-SCC6 (150x150mm)	✓	✓	✓	✓	U	U	U
SCI-SCC12 (300x300mm)	×	×	×	✓	✓	✓	✓



# UHE Solar Simulator Series

## DIMENSIONS

UHE-NS with Downward Facing Beam. [mm]

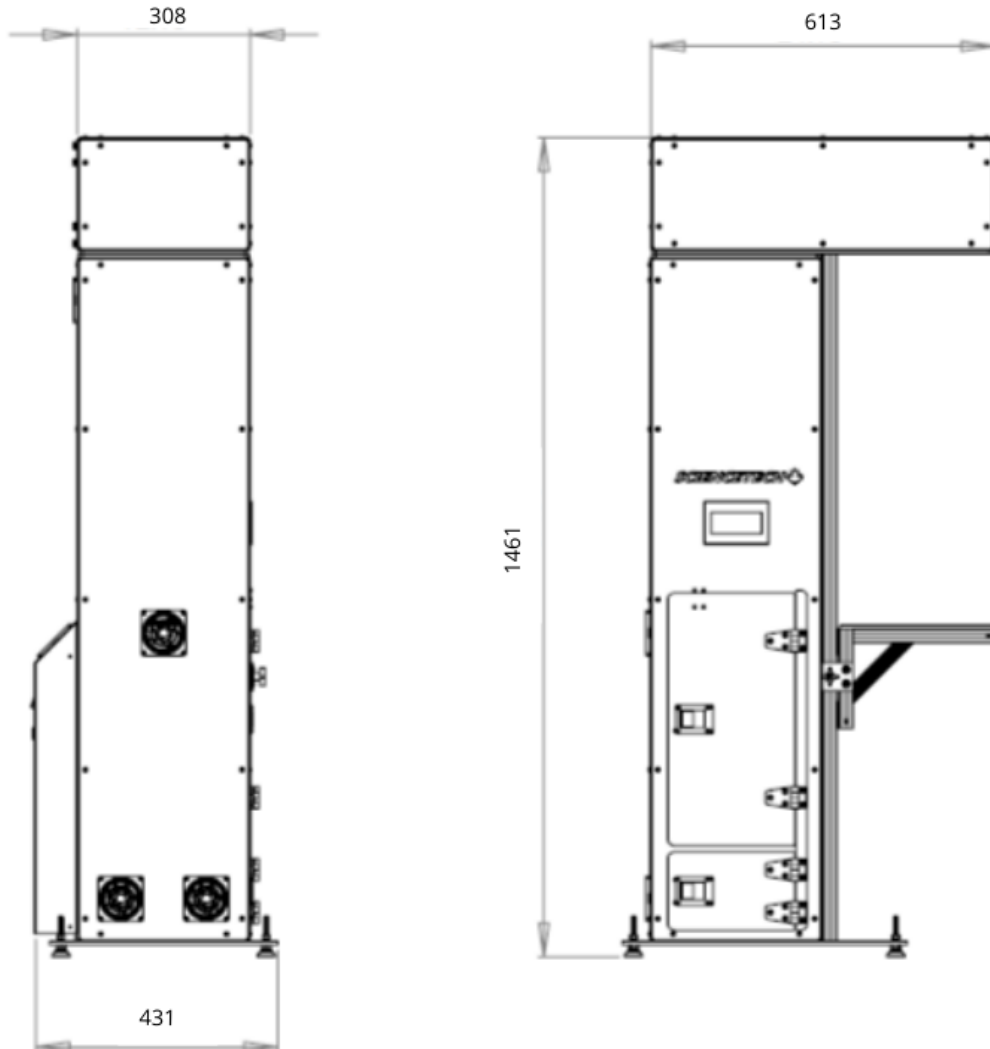

### Mounting Options

- 1/4-20 Levelling feet provided standard
- Optional hold down brackets available

# UHE Solar Simulator Series

## DIMENSIONS

UHE-NL with Downward Facing Beam. [mm]

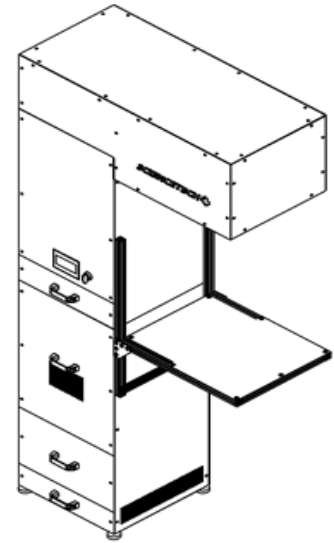
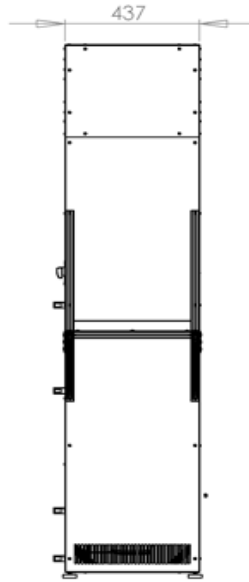
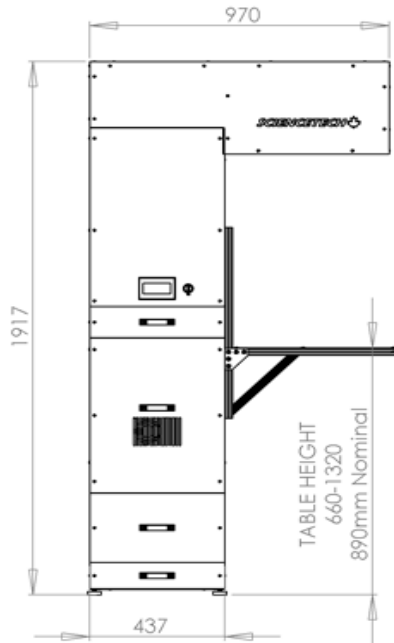

### Mounting Options

- 1/4-20 Levelling feet provided standard
- Optional hold down brackets available

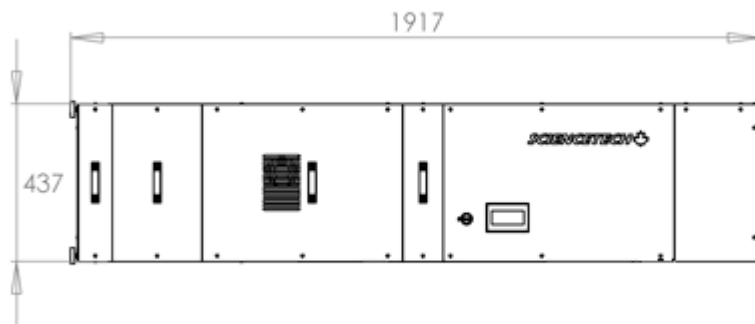

UHE-NL Horizontal Beam Option