

Marana

sCMOS

Ultimate Sensitivity Back-illuminated sCMOS
for Astronomy and Physical Sciences

Key Applications

- ✓ Space Debris Tracking
- ✓ Quantum Gases
- ✓ Near Earth Object Tracking
- ✓ Tomography
- ✓ Wavefront Sensing
- ✓ Spectroscopy
- ✓ Wafer Inspection
- ✓ Plasma Studies
- ✓ Hyperspectral Imaging
- ✓ Speckle Interferometry

Key Specifications

- High Resolution: 4.2 Megapixel
- High Sensitivity: Up to 95% QE
- Fast Speeds: Up to 74 fps
- Large Field of View: Up to 32 mm
- Deep Cooled: -45°C cooling
- Protected: UltraVac™ sensor enclosure
- Flexible: 11 μm & 6.5 μm pixel sensors



Introducing Marana



Marana is Andor's new flagship high performance, vacuum cooled sCMOS camera platform, specifically for applications within physical sciences and astronomy. Designed from the ground up to deliver market leading performance and versatility. Crucially, Marana sCMOS reads out 4.2 Megapixel high resolution arrays in less than 50 milliseconds while maintaining very low read noise; hundreds of times faster than a similar resolution CCD detector.

Marana 2k x 2k sCMOS - 'low noise readout'

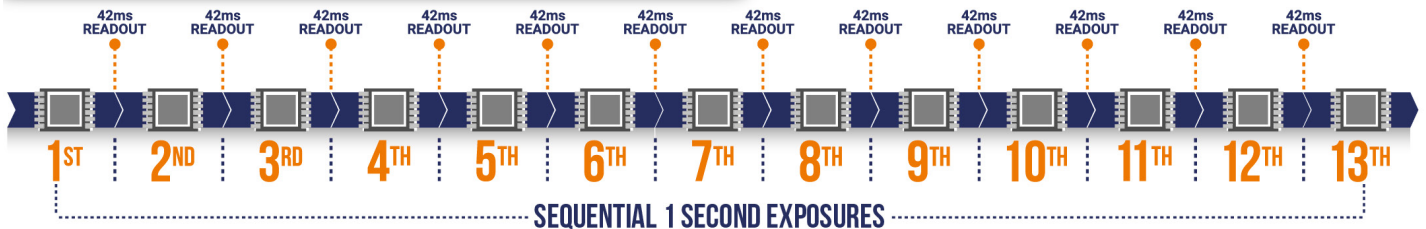

2k x 2k CCD (4 output ports) - 'low noise readout'

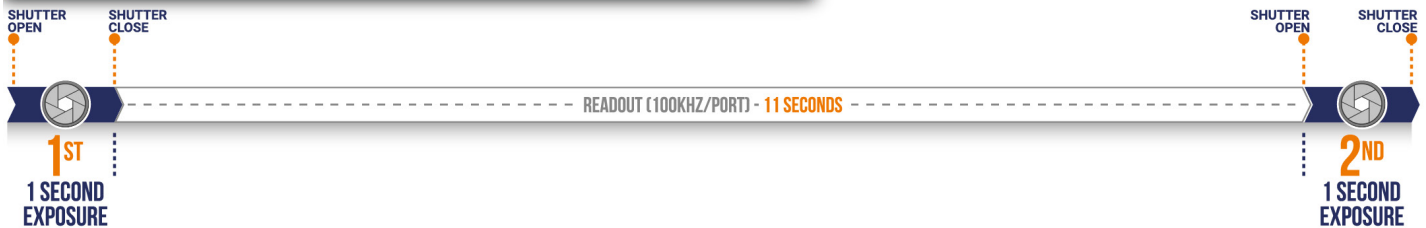

The Most Sensitive Back-illuminated sCMOS

Marana 4.2B-11 and new **Marana 4.2B-6** back-illuminated sCMOS cameras feature up to **95% Quantum Efficiency** combined with Andor's unique **vacuum cooling to -45°C**, minimizing noise. Since back-illuminated sensors are chosen specifically for enhanced sensitivity, it makes sense to choose the most sensitive adaption of this high end technology.

How do we benefit from enhanced sensitivity?

- ✓ Space debris & NEO – track smaller objects
- ✓ Detect smaller occultations
- ✓ Lower laser powers – preserve photosensitive samples
- ✓ Shorter exposures – follow fast events, e.g. pulsars and fast reactions
- ✓ Lower detection limits / trace concentrations
- ✓ Higher dynamic range photometry
- ✓ AO wavefront sensing on weaker signals
- ✓ Extremely narrowband filters (e.g. Solar)
- ✓ Fluorescence down to single ultra-cold atoms



Features and Benefits

From Quantum Gas Dynamics to Astronomical Occultations, Marana combines the sensitivity, speed, resolution and field of view to take on the most demanding of imaging or spectroscopic challenges.

Feature	Benefit
All Marana Models	
Up to 95% QE & lowest noise	Maximum signal to noise for light starved measurements. Detect smaller orbital debris; BEC fluorescence.
Vacuum cooled to -45°C	Very weak signals require lowest noise floor and longer exposures: Don't be restricted by camera thermal noise!
4.2 Megapixel	High pixel resolution, maintaining image clarity over an extended field of view.
The ONLY vacuum back-illuminated sCMOS¹	Andor's proprietary UltraVac™ technology protects the sensor from (a) QE degradation, and (b) moisture condensation.
Extended Dynamic Range (EDR) Mode	'One snap quantification' across the full dynamic range - perfect for Photometry.
> 99.7% linearity	Market leading quantitative accuracy over the whole signal range.
Fan and liquid cooling as standard	Liquid cooling for maximum sensitivity.
Adaptive Optics Ready	Minimize lag after data collection - transfer of row data immediately after exposing.
Marana 4.2B-11 (11 µm pixels)	
Anti-Glow Technology	Suppresses the effects of sensor amplifier glow, allowing access to the full 4.2 Megapixel array.
11 µm pixels and 32 mm sensor diagonal	Largest field of view sCMOS, compatible with wide range of acquisition times. Large sky scanning; Tomography.
UV-optimized QE option	Enhanced UV sensitivity between 260 - 400 nm. Wafer Inspection (266 nm).
NEW Marana 4.2B-6 (6.5 µm pixels)	
6.5 µm pixels	Smaller pixels better suited to some optical systems, e.g. echelle astrospectroscopy and cold atom imaging.
USB 3.0 and CoaXPress connectivity options	USB 3.0 provides flexibility. CoaXPress enables the highest speeds to capture the most dynamic events.
Low Noise Mode	Further reduces read noise floor at expense of pixel well depth, while maintaining a fast frame rate. Ideal when highest possible sensitivity is a priority.
High Speed Mode	Acquire images at high speeds of up to 74 fps in full frame 16-bit mode via CoaXPress! Boost speeds even further using regions of interest.
Superfast Spectroscopy Ready	On-head vertical pixel binning, ideal for dynamic spectroscopy (up to >25,000 spectra/sec).

The Marana sCMOS series

Marana 4.2B-11: Superior Field of View

The **Marana 4.2B-11** is the detector of choice when field of view and sensitivity are required. Andor's unique glow suppression approach enables you to usefully and uniquely access the entire 2048 x 2048 pixel array of the GSense 400 BSI sensor, offering an impressive 32 mm sensor diagonal.

Marana 4.2B-11 presents an exclusive solution for capturing a large field of view across a wide range of exposure conditions, from microseconds up to several seconds.

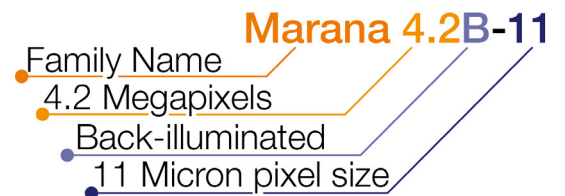

How do we benefit from a larger field of view?

- ✓ Search more sky – Space Debris and NEO tracking
- ✓ Capture Sun Spots & Solar Flares
- ✓ Tomography – reconstruct larger objects without sacrificing resolution
- ✓ Wafer inspection with high throughput (266 nm)

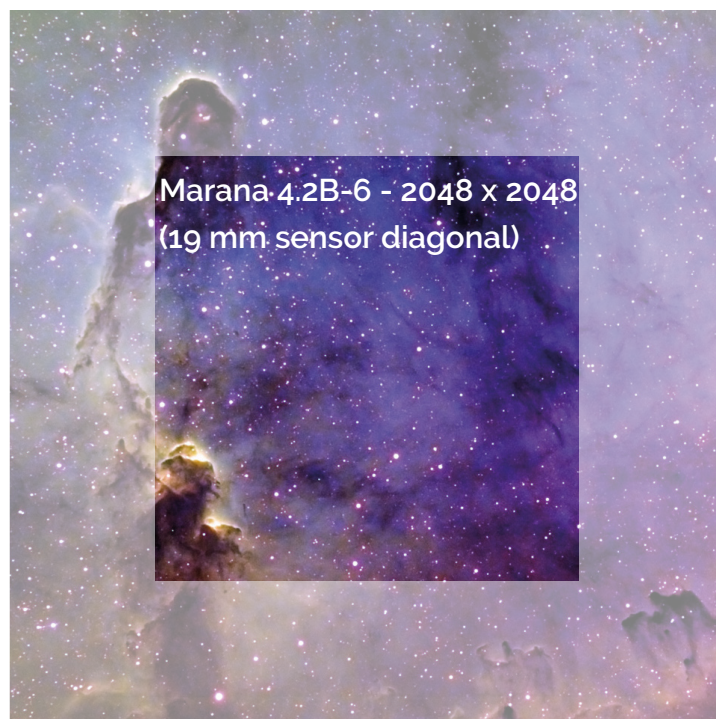

Marana 4.2B-6: Fastest Speed

Marana 4.2B-6 is the most sensitive back-illuminated camera available for imaging or spectroscopic applications requiring higher speed, reaching 74 fps with full 16-bit data range. Applications include quantum gas dynamics, fast high resolution spectroscopy, fast image stacking (for further extending dynamic range), hyperspectral imaging and non-destructive imaging of movement via X-ray or Neutron Radiography.

The smaller 6.5 μm pixel is better suited to resolution matching across many laboratory-based optical imaging configurations, as well as in echelle spectroscopy.



NEW

Marana 4.2B-6

- Family Name
- 4.2 Megapixels
- Back-illuminated
- 6.5 Micron pixel size

Extend Dynamic Range - Fast Image Stacking

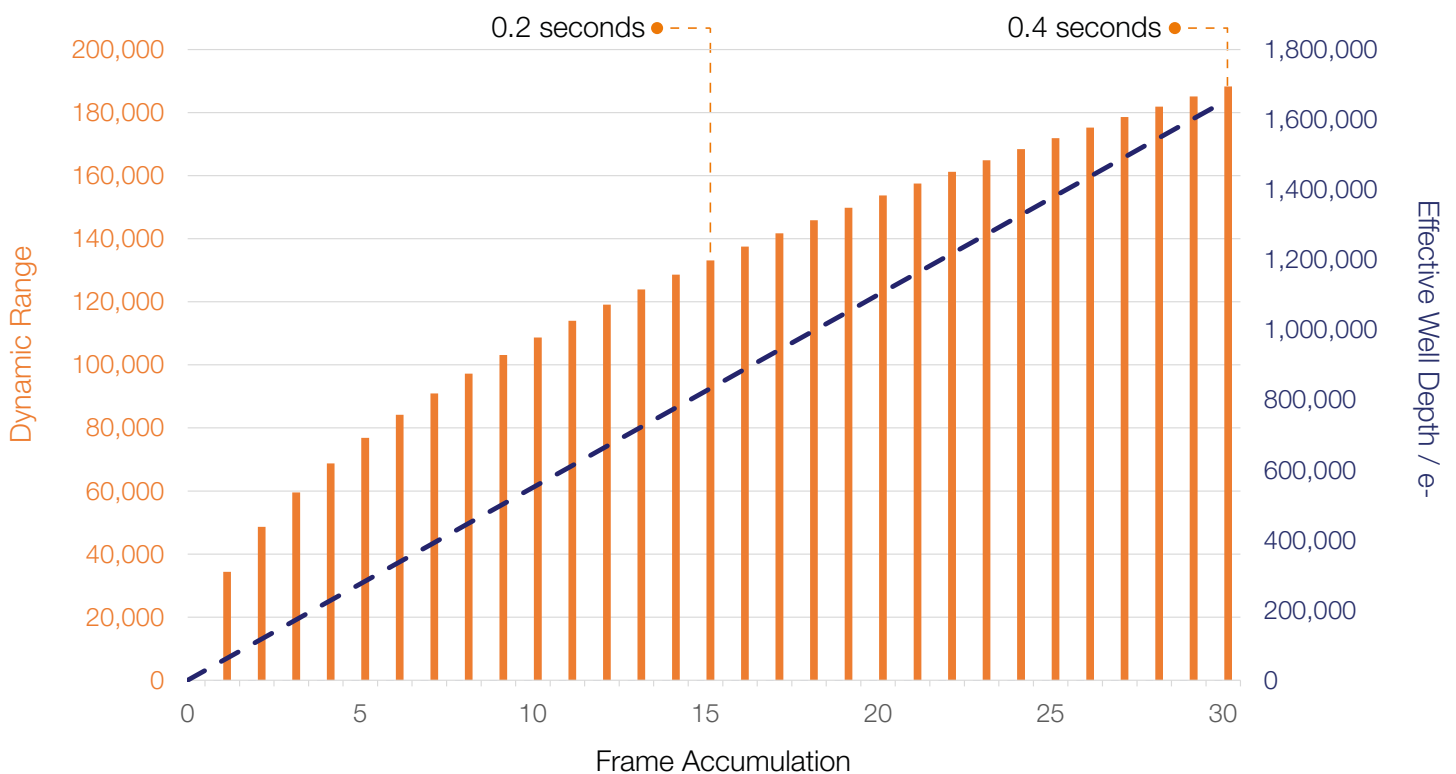

Dynamic Range and Effective Well Depth as a function of the number of stacked (accumulated) frames, plotted for Marana 4.2B-6. A Dynamic Range of 188,280:1, and a corresponding Effective Well Depth of 1,650,000 electrons can be reached with only 30 stacked frames. At maximum frame rate, this number of accumulated frames takes only 0.4 secs to acquire, achieving > 2 fps. This capability is significant for a range of challenges across imaging and spectroscopic characterisations.

Key Features

Large Field of View

The 32 mm sensor diagonal of Marana 4.2B-11 covers more sky at high resolution in astronomical observations, improving statistics of detection and tracking.

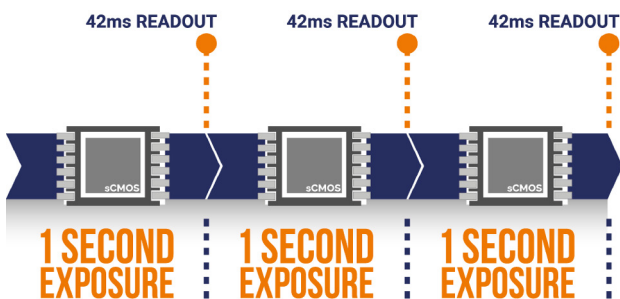

Fast Sensor Readout

Taking only 13.5 milliseconds (4.2B-6) or 42 milliseconds (4.2B-11) per 16-bit full frame readout, Marana can measure photometric variability across a wide range of timescales, ideal for imaging rapid celestial changes and fast measurements of Quantum Gas dynamics.

Extended Dynamic Range

On-chip dual-amplifier design means the whole photometric range, from the noise floor up to the saturation limit, can be captured with one image. The wide dynamic range is complimented by enhanced on-head intelligence to deliver linearity > 99.7%, for unparalleled quantitative photometric accuracy across the full signal range.

Combine with fast image stacking (accumulation) to extend dynamic range even further.

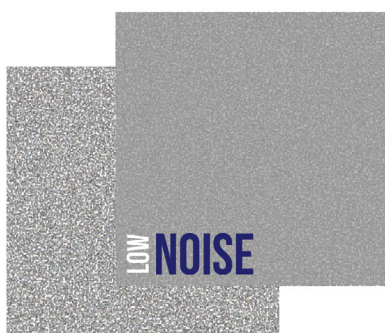

Highly Sensitive

The back-illuminated sensors of Marana ensure a peak QE of 95%, with broad response across the UV-VIS-NIR range. The massively parallel readout architecture and innovative pixel design enables Marana to drive very low read noise performance, < 2 e⁻, while still achieving maximum readout speed and full dynamic range. Marana 4.2B-6 offers a further low noise mode to achieve 1.2 e⁻ noise at reduced pixel well depth – ideal for fluorescent quantum gas measurements of low atom numbers.

Key Features

Vacuum Sensor Enclosure

sCMOS cameras from other manufacturers use O-ring sealed, back-filled sensor enclosures, susceptible to moisture ingress and routine factory maintenance. Andor is the only manufacturer of vacuum enclosed sCMOS cameras, based on our proven UltraVac™ process, offering superior cooling and ultimate sensor protection. Expect the vacuum to hold firm, year after year.

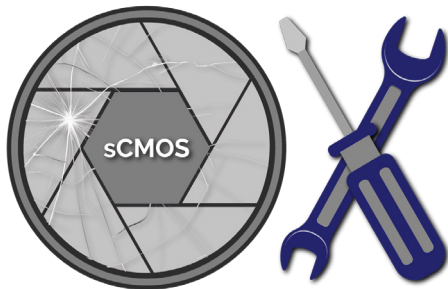
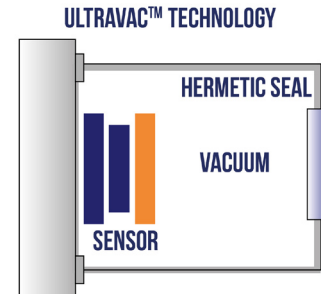

No Mechanical Shutter

Applications that involve frequent cycling of mechanical shutters, such as exoplanet studies or X-ray tomography, require routine shutter replacements and associated down time. Marana offers on-sensor Rolling Shutter, thus overcomes the need for mechanical shutters. Furthermore, this avoids the exposure gradient effects associated with that of an iris shutter, thus much better for accurate photometry.

Low Maintenance Astronomy

The vacuum enclosure and shutter-free longevity benefits of Marana are particularly relevant to the needs of astronomers, where cameras are often in remote unmanned observing locations and need to operate without service intervention, over long durations of time. This ultimately translates not only into greater experimental efficiency, but also into a lower cost of ownership.

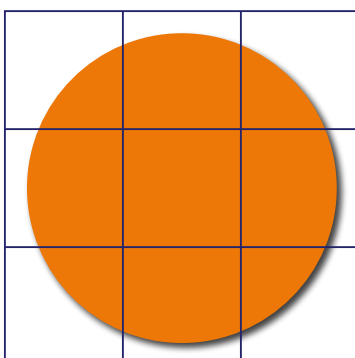

Pixel Size Options

The 11 μm or 6.5 μm pixel sizes of the available Marana models offer a solution to more closely resolution match the camera to the specific optical configuration. Pixel binning offers further usage flexibility.

Application Focus

Solar System Objects

A Near-Earth Object (NEO) is any small Solar System body whose orbit brings it into proximity with Earth. Over 20,000 known Near Earth Asteroids have been discovered, of which almost 1000 are larger than 1 km. The inventory is much less complete for smaller objects, which still have potential for large scale damage. While asteroids are constantly being eliminated from our solar system, unfortunately new ones are pulled into orbit. Thus, NEO surveys are required as an ongoing discipline in astronomy. The large field of view, very high sensitivity and fast readout of Marana 4.2B-11 is ideal for enhancing statistics of object detection, either directly visualised or by occultation.

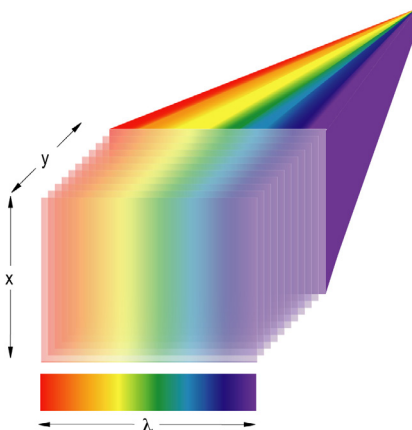

Hyperspectral

Marana is ideal for fast, high dynamic range spectral imaging, either: (a) hyperspectral configurations (push-broom or otherwise), enabling full data cubes to be rapidly acquired, or (b) high density multi-track spectroscopy at fast spectral rates and/or very high dynamic range through image stacking. For example, Marana 4.2B-6 can acquire 10 spectral tracks at almost 1500 fps, and can acquire a single spectrum at up to 25,000 fps.

X-Ray or Neutron Tomography

For high throughput 3D tomography (or even 4D: 3D + time), the high resolution Marana 4.2B-11 or Marana 4.2-6 back-illuminated sCMOS models, featuring low noise, fast readout and 95% QE, present a superb solution. Lens/scintillator coupled tomography using Marana enables reconstruction of large objects without sacrificing resolution and clarity. Lack of mechanical shutter means shutter lifetime is not an issue, reducing downtime.

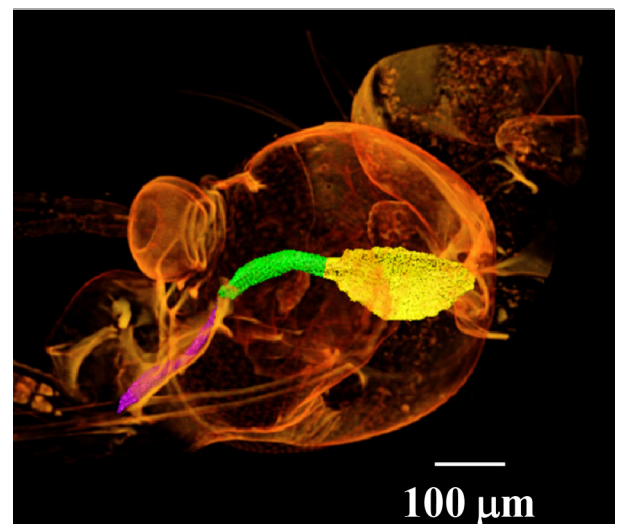
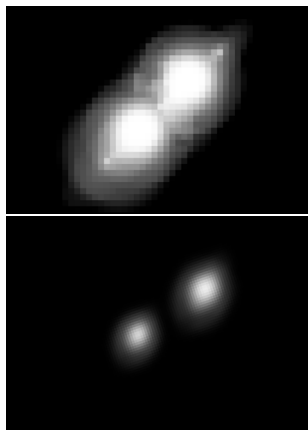

Image courtesy of Prof. S.J. Lee & Dr. Ha, Pohang University of Science and Technology (POSTECH), Republic of Korea.

Application Focus

Quantum Gases

Marana 4.2B-11 or Marana 4.2B-6 can be readily integrated into optical systems for imaging ultracold quantum gases, such as Bose Einstein Condensates. The rapid frame rates of Marana 4.2B-6 is ideal for fast, continuous (not burst) dynamic studies, market-leading sensitivity enabling high SNR capture of even small numbers of trapped atoms.



Resolution Enhancement

Lucky/Speckle Imaging - Marana models can be used for the 'Atmospheric Freezing' techniques of Lucky and Speckle Imaging, enabling resolution enhancement of ground-based astronomy over a large field of view. The 74 fps (full array) with 100% duty cycle of Marana 4.2B-6 means that enhanced resolution images can be generated within a few seconds of acquisition.

Wavefront Sensing – Marana 4.2B-6 is an ideal fast wavefront sensor for Adaptive Optics. A 128x128 ROI yields 1165 fps, and individual pixel rows can be transmitted immediately after recording for on-the-fly image processing with minimal time lag.

Orbital Debris

Orbital Debris, or Space Debris, are terms for the mass of defunct human-made objects in Earth orbit, such as old satellites and spent rocket stages. There are about 500,000 pieces of 'space junk' down to items about 0.5 inches (1.27 cm) wide in orbit. Of those, about 21,000 objects are larger than 4 inches (10.1 cm) in diameter. Marana 4.2B-11 offers a very large area and is a superb detector solution for ground based Orbital Debris tracking, capable of searching more sky while maintaining high resolving capability. Low noise enables high-quality data capture of even relatively small (and dim) objects, and rapid frame rates enable temporal oversampling of fast moving/rotating objects.



Different Modes for Marana

Multi-track Mode

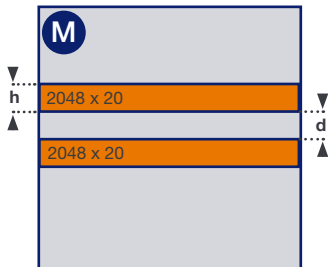

Up to 256 vertically binned tracks can be used for multi-track analysis without sacrificing speed.

Imaging Mode

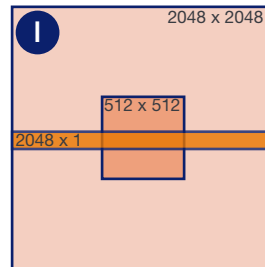

The array size may be defined for either resolution or maximum speed.

Spectroscopy Mode

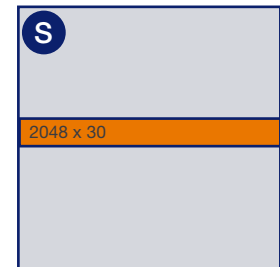

A vertically binned track is centred on the sensor enabling the maximum spectral rate to capture dynamic events.

I Imaging Mode 4.2B-11

Frame rate table

ROI Size (W x H)	Max Frame Rate (fps)		ROI area (of sensor)	Example scenarios of use
	16-bit	12-bit (Fast Speed)		
2048x2048	24	48	22.5 mm x 22.5 mm	Full FOV imaging, Space debris, NEOs, Hyperspectral
2048 x 1200	41	81	22.5 mm x 13.2 mm	High density multitrack on Kymera/Shamrock
1608x1608	30	61	17.7 mm x 17.7 mm	Reduced ROI, faster frame rates
1400x1400	35	70	15.4 mm x 15.4 mm	
1200x1200	41	81	13.2 mm x 13.2 mm	
1024x1024	48	95	11.3 mm x 11.3 mm	
512x512	95	190	5.6 mm x 5.6 mm	
256x256	190	378	2.8 mm x 2.8 mm	
128x128	378	750	1.4 mm x 1.4 mm	
2048x8	5415	9747	22.5 mm x 88 μm	Single or dual track spectroscopy
2048x2	16244	24367	22.5 mm x 22 μm	Single track spectroscopy
2048x1	24367	24367	22.5 mm x 11 μm	Single track spectroscopy with ultrafast rates

M Multi-track Mode 4.2B-11

Vertically binned tracks (overlap ON)

Number of Tracks	Track height (h)		Track separation (d)		Max Acquisition Rate	
	Pixels	μm	Pixels	μm	16-bit	12-bit (Fast Speed)
2	10	110	10	110	2,321	4,430
2	10	110	0	0	2,321	4,430
2	20	220	10	110	1,189	2,321
6	50	550	40	440	162	323
10	10	110	0	0	483	956
10	20	220	0	0	242	483
10	30	330	30	330	162	323
50	20	220	0	0	49	97
60	20	220	0	0	41	81
100	20	220	0	0	24	49

S Spectroscopy Mode 4.2B-11
Vertically binned tracks (overlap ON)

Array Size (W x H)	Max Spectra Rate	
	16-bit	12-bit (Fast Speed)
any x 1	24367	24367
any x 2	16244	24367
any x 8	5415	9747
any x 1200	41	81
any x 2048	24	48

S Spectroscopy Mode 4.2B-6
Vertically binned tracks (overlap ON)

Array Size (W x H)	Max Spectra Rate	
	16-bit	12-bit (Low Noise)
any x 1	25253	14881
any x 2	25253	14881
any x 8	15152	8929
any x 1200	126	74
any x 2048	74	44

I Imaging Mode 4.2B-6
Frame rate table

ROI Size (W x H)	Max Frame Rate (fps)				ROI area (of sensor)
	USB 3.0		CoaXPress		
	16-bit	12-bit (Low Noise)	16-bit	12-bit (Low Noise)	
2048x2048	40	43	74	44	13.3 mm x 13.3 mm
1400x1400	85	63	108	64	9.1 mm x 9.1 mm
1200x1200	116	74	126	74	7.8 mm x 7.8 mm
1024x1024	148	87	148	87	6.7 mm x 6.7 mm
512x512	295	174	295	174	3.3 mm x 3.3 mm
256x256	587	346	587	346	1.7 mm x 1.7 mm
128x128	1165	686	1166	687	0.8 mm x 0.8 mm

M Multi-track Mode 4.2B-6
Vertically binned tracks (overlap ON)

Number of Tracks	Track height (h)		Track separation (d)		Max Acquisition Rate	
	Pixels	µm	Pixels	µm	16-bit	12-bit (Low Noise)
2	10	65	10	65	6887	4058
2	10	65	0	0	6887	4058
2	20	130	10	65	3608	2126
6	50	325	40	260	502	296
10	10	65	0	0	1485	875
10	20	130	0	0	750	442
10	30	195	30	195	502	296
50	20	130	0	0	151	89
60	20	130	0	0	126	74
100	20	130	0	0	76	45

Note: Frame/spectral rates do not differ if partial or full rows are selected. For Marana 4.2B-6 for frame rates using USB 3.0 for Multi-track and Spectroscopy modes please see our technical note: Marana Frame Rates, which is available in our [Learning Center](#).

Technical Data²

Model	Marana 4.2B-11	NEW Marana 4.2B-6
Sensor Type	Back-Illuminated Scientific CMOS	
Array Size	2048 (W) x 2048 (H) 4.2 Megapixel	
Pixel Size	11 x 11 μm	6.5 x 6.5 μm
Image Area	22.5 mm x 22.5 mm (31.9 mm diagonal)	13.3 mm x 13.3 mm (18.8 mm diagonal)
Readout Modes	Rolling Shutter	
Pixel Readout Rates	100 MHz (High Dynamic Range mode, 16-bit) 200 MHz (Fast Speed mode, 12-bit)	310 MHz (Fast High Dynamic Range mode, 16-bit) 180 MHz (Low Noise mode, 12-bit)
Quantum Efficiency³	up to 95%	
Read Noise (e⁻) median	1.6 e ⁻ (at any readout rate)	1.6 e ⁻ (Fast High Dynamic Range mode, 16-bit) 1.2 e ⁻ (Low Noise mode, 12-bit)
Sensor operating temperature⁴ Air cooled Water/liquid cooled	-25°C (up to 30°C ambient) -45°C (@16°C water)	
Dark Current⁵ Air cooled (@-25°C) Water/liquid cooled (@ -45°C)	0.7 e ⁻ /pixel/s 0.3 e ⁻ /pixel/s	0.15 e ⁻ /pixel/s 0.10 e ⁻ /pixel/s
Active area pixel well depth	85 000 e ⁻ (High Dynamic Range mode, 16-bit) 2600 e ⁻ (Fast Speed mode, 12-bit, bit depth limited)	55 000 e ⁻ (Fast High Dynamic Range mode, 16-bit) 1800 e ⁻ (Low Noise mode, 12-bit, bit depth limited)
Dynamic Range	53 000:1 (High Dynamic Range mode, 16-bit)	34 000:1 (Fast High Dynamic Range mode, 16-bit)
Data Range	16-bit (High Dynamic Range mode) 12-bit (Fast Speed mode)	16-bit (Fast High Dynamic Range mode) 12-bit (Low Noise mode)
Linearity⁶	> 99.7%	
PRNU	< 0.5% (@ half-light range)	
Region of Interest (ROI)	User-definable, 1 pixel granularity, min. size 25 (w) x 1 (h)	User-definable, 1 pixel granularity, min. size 9 (w) x 1 (h)
Pre-defined ROI	1608 x 1608, 1200 x 1200, 1024 x 1024, 512 x 512, 128 x 128	
Pixel Binning (on FPGA)	2 x 2, 3 x 3, 4 x 4, 8 x 8 (user-definable binning also available)	

Model	Marana 4.2B-11	NEW Marana 4.2B-6
I/O	O: Fire Row 1, Fire Row n, Fire All, Fire Any, Arm I: External	
Trigger Modes	Internal, External, External Start, External Exposure, Software	
Software Exposure Events⁷	Start exposure - End exposure (row 1), Start exposure - End exposure (row n)	
Image Timestamp Accuracy	25 ns	
PC Interface	USB 3.0 ⁸	USB 3.0 ⁸ and CoaXPress
Camera Window	AR coated UV grade fused silica window	
Lens Mount	F-mount*	C-Mount

* Optional user-switchable C-Mount accessory available for use with smaller ROI sizes.

Quantum Efficiency *3

All cameras in the Marana platform feature back-illuminated sensor architecture which allows collection of light from the sample without circuitry blocking the photosensitive area of the detector.

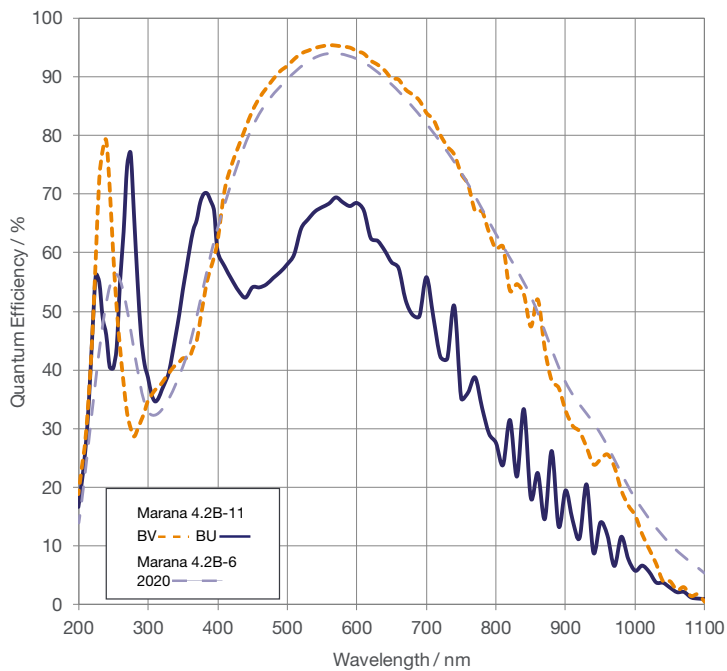

UV Flexibility with Marana 4.2B-11

Marana 4.2B-11 comes with two sensor options, 'BV' and 'BU'. Each offer a particular performance profile across the Blue/UV region, with the 'BU' sensor in particular showing greater optimization across this range, offering high QE solutions for both 266 nm and 355 nm laser lines.

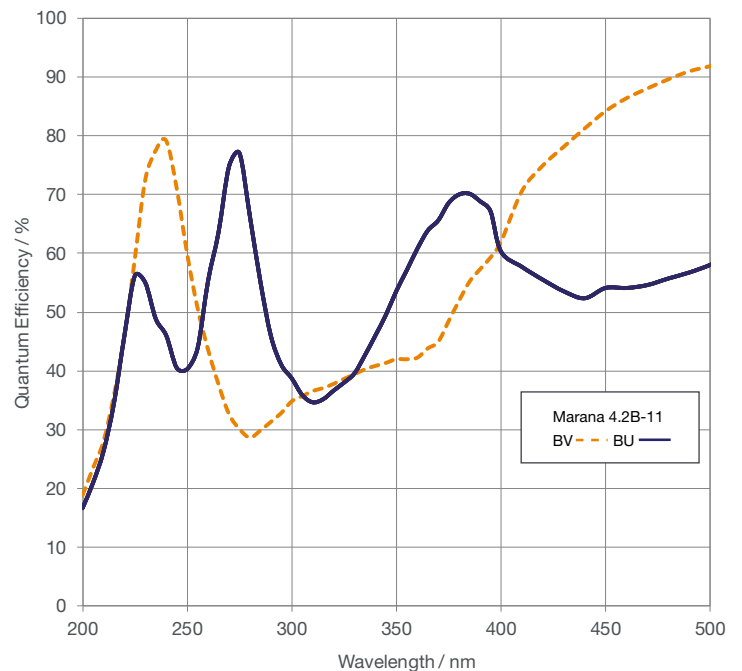

Flexible Connectivity

- 1 USB 3.0*8**
A convenient, universally available high speed interface.
 - 2 TTL / Logic**
Connector type: 15-way D-type to BNC cable with Fire (Output), External Trigger (Input), Shutter (Output).
 - 3 CoaXPress (Marana 4.2B-6 only)**
CoaXPress (2 lane) offers the highest speed data interface
- W Water Cooling**
Connection to recirculator or other water/liquid cooling system is possible for maximum sensitivity.
- P Power**
Connection to PSU refer to power requirements on page 16.

Notes: Minimum cable clearance required at rear of camera: 100 mm.

Marana 4.2B-6 Purchase Flexibility

Don't want to commit to CoaXPress connectivity from the outset? If preferred, order the less expensive USB 3.0-only version and later avail of a simple in-field upgrade to CoaXPress capability, using the **CHAM-UPG-CXP** code, if and when additional speed is needed. The upgrade includes CoaXPress card, cable and remote session to upgrade camera firmware and unlock CoaXPress capability. Please contact your sales representative for more information.

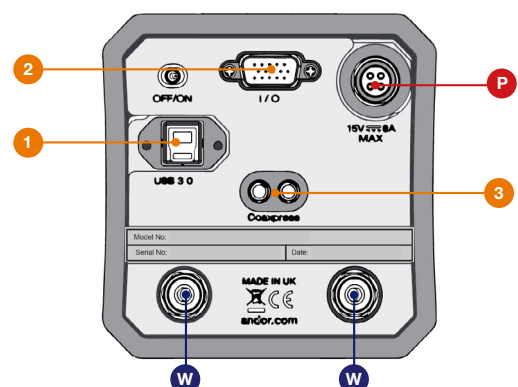

Creating the Optimum Product for you

Step 1. Choose the camera type

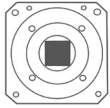

Camera Type

Description	Code
Marana 4.2B-11: 4.2 Megapixel Back-illuminated sCMOS, VIS/NIR optimized, 11 μ m pixel, 95% QE, 48 fps, USB 3.0, F-mount*	MARANA-4BV11
Marana 4.2B-11: 4.2 Megapixel Back-illuminated sCMOS, UV-optimized, 11 μ m pixel, 95% QE, 48 fps, USB 3.0, F-mount*	MARANA-4BU11
Marana 4.2B-6: 4.2 Megapixel Back Illuminated sCMOS, 6.5 μ m pixel, 95% QE, 43 fps, USB 3.0, C-mount	MARANA-4BV6U
Marana 4.2B-6: 4.2 Megapixel Back Illuminated sCMOS, 6.5 μ m pixel, 95% QE, 74 fps, USB 3.0 and CoaXPress, C-mount	MARANA-4BV6X

* Optional user-switchable C-Mount accessory available for use with smaller ROI sizes.

Step 2. Select an alternative camera window (optional)



Camera Window

The standard window has been selected to satisfy most applications. However, other options are available. The alternative camera window code must be specified at time of ordering.

To view and select other window options please refer to the table in the Technical Note – '[Camera Windows Supplementary Specification Sheet](#)' which gives the transmission characteristics, product codes and procedure for entering the order. Further detailed information on the windows can be found in the Technical note – '[Camera Windows: Optimizing for Different Spectral Regions](#)'.

Step 3. Select the required accessories



Accessories

Description	Order Code
C-mount - convert Marana 4.2B-11 to C-mount (for use with smaller Regions of Interest)	ACC-MEC-11936
F-mount - F-mount kit used to convert Marana 4.2B-6 for use with F-mount lenses (e.g. accessing smaller f#)	F-MOUNT-ADP-KIT
Mounting flange for Kymera 328i and 193i spectrographs	MFL-KY-MARANA
Mounting flange for the Shamrock 500i	MFL-SR500-MARANA
Re-circulator for enhanced cooling performance (supplied with 2x2.5 m tubing as standard)	XW-RECR
Oasis 160 Ultra compact chiller unit (tubing to be ordered separately)	ACC-XW-CHIL-160
6 mm tubing options for Oasis 160 Ultra compact chiller (2x2.5 m or 2x5 m lengths)	ACC-6MM-TUBING-2X2.5 ACC-6MM-TUBING-2X5M

Note: Other mounting options are available through our CSR process - please contact your sales representative.

Step 4. Select the required software



Software

Marana requires one of the following software options:

Solis Imaging A 32-bit and fully 64-bit enabled application for Windows (8, 8.1 and 10) offering rich functionality for data acquisition and processing. AndorBasic provides macro language control of data acquisition, processing, display and export.

Andor SDK3 A software development kit that allows you to control Andor sCMOS cameras from your own application. Available as a 32-bit or 64-bit library for Windows (8, 8.1 and 10) and Linux. Compatible with C/C++, LabView and Matlab.

GPU Express Andor GPU Express library has been created to simplify and optimize data transfers from camera to a CUDA-enabled NVidia Graphical Processing Unit (GPU) card to facilitate accelerated GPU processing as part of the acquisition pipeline. Integrates easily with Andor SDK3 for Windows.

Third party software compatibility Drivers are available for a variety of third party imaging packages. See Andor website for detail: <https://andor.oxinst.com/learning/view/article/third-party-imaging-software-support>

Mechanical Drawings

Dimensions in mm [inches]
(shown for F-mount)

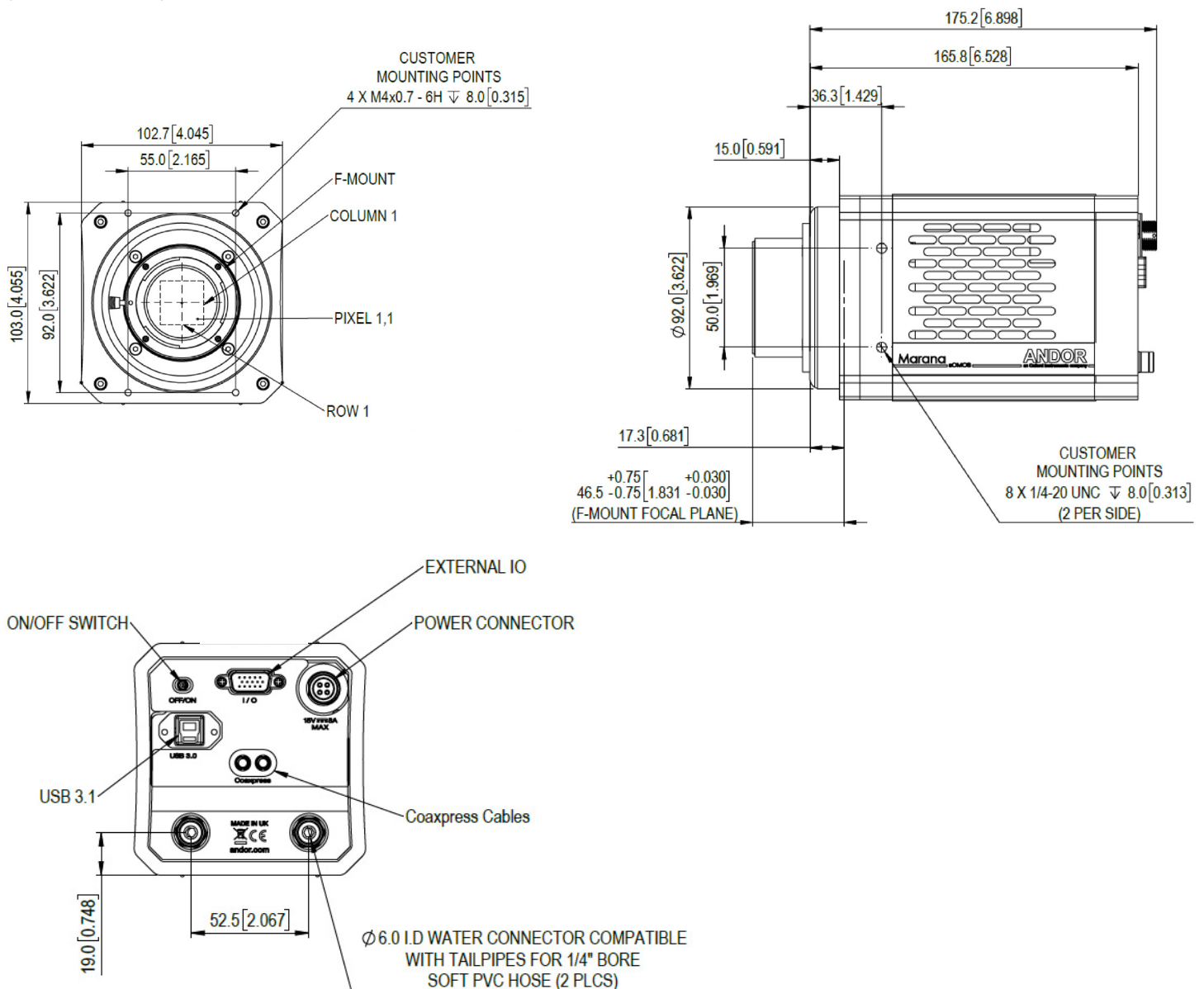

Note: Operational CoaXPress connection only available with MARANA-4BV6X
Weight: ~2.7 kg [5.95 lbs] approx.

Have you found what you are looking for?

Need Larger Field of View? [Balor sCMOS](#) offers a 16.9 Megapixel sensor with 12 μ m pixel pitch, reading the entire array in only 18.5 milliseconds.

Need faster frame rates? The [Zyla sCMOS](#) platform, configured with CameraLink interface, can deliver 100 fps from a full 5.5 or 4.2 Megapixel array, faster still with sub-array selection.

Need more sensitivity? The [iXon Ultra EMCCD](#) platform offers single photon sensitivity and 95% back-illuminated QE, further boosted by cooling down to -100°C. Ideal for demanding light starved or single photon counting applications such as quantum entanglement studies.

Need better NIR performance? The [iKon-M and iKon-L range of CCDs](#) offer NIR-Enhanced QE options ('BR-DD' and 'BEX2-DD'), extending sensitivity deep into the NIR range. Ideal for exoplanet detection on dwarf stars as well as 785 nm laser usages (e.g. BEC and NIR Raman).



Order Today

Need more information? At Andor we are committed to finding the correct solution for you. With a dedicated team of technical advisors, we are able to offer you one-to-one guidance and technical support on all Andor products.

For a full listing of our local sales offices, please see: andor.com/contact

Our regional headquarters are:

Europe

Belfast, Northern Ireland
Phone +44 (28) 9023 7126
Fax +44 (28) 9031 0792

North America

Concord, MA, USA
Phone +1 (860) 290 9211
Fax +1 (860) 290 9566

Japan

Tokyo
Phone +81 (3) 6732 8968
Fax +81 (3) 6732 8939

China

Beijing
Phone +86 (10) 5884 7900
Fax +86 (10) 5884 7901



Items shipped with your camera

- 1x USB 3.0 PCIe card⁷
 - 1x USB 3.0 Cable (3 m)⁷
 - 1x Multi I/O Timing Cable (BNC to D-type: 1.5 m)
 - 1x 15 V PSU
 - 1x Country specific power cord
 - 1x User manuals in electronic format
 - 1x Quickstart Guide
 - 1x Individual system performance booklet
- Marana 4.2B-6 with CoaXPress also includes:
- 1x CoaXPress 3.0 PCIe card with external trigger
 - 1x CoaXPress Cable (3 m)
 - 1x Multi I/O Timing Cable (BNC to SMB: 1.5 m)

Footnotes

1. Assembled in a state-of-the-art facility, Andor's UltraVac™ vacuum process combines a permanent hermetic vacuum seal (no O-rings), with a stringent protocol and proprietary materials to minimize outgassing. Outgassing is the release of trapped gases that would otherwise degrade cooling performance and potentially cause sensor failure.
2. Figures are typical and target specifications and therefore subject to change.
3. Quantum efficiency as supplied by the sensor manufacturer.
4. Coolant temperature must be above dew point.
5. Read noise measured at 0°C (Marana 4.2B-6) and 15°C (Marana 4.2B-11).
6. Linearity is measured from a plot of Signal vs. Exposure Time over the full dynamic range.
7. Software Exposure Events provide rapid software notification (SDK only) of the start and end of acquisition.
8. Marana connects to your control PC using a USB 3.0 connection. This may also be referred to as USB 3.1 (Gen 1). Andor provide a USB 3.0 card and cable, and recommend that these are used to ensure optimum performance.

andor.com



Minimum Computer Requirements:

- 3.0 GHz single core or 2.4 GHz dual or quad core processor
- 8 GB RAM
- Hard drive: 850 MB/sec write speed recommended for the data rate associated with the max. frame rates. 250 MB free hard disc to install software
- USB 3.0 slot (or x4 PCIe slot for USB 3.0 card)
- x8 PCIe slot for CXP PCIe card
- Windows (8, 8.1 and 10) or Linux

Operating & Storage Conditions:

- Operating Temperature: 0°C to +30°C ambient
- Operating Altitude: up to 6000 m
- Relative Humidity: <70% (non-condensing)
- Storage Temperature: -10°C to 50°C

Power Requirements:

- 100 - 240 VAC, 50 - 60 Hz
- Power consumption: 40 - 46 W typical / 114W max (model dependent)



Windows is a registered trademark of Microsoft Corporation.
Labview is a registered trademark of National Instruments.
Matlab is a registered trademark of The MathWorks Inc.

MARANAFAMILY SS 0320 R1